



AF-35/40

Shown with optional casters.
Hand polished stainless steel finish.

FEATURES

- Stainless Steel heavy duty construction.
- Extra depth oil level for frying larger products.
- Front slanting vessel bottom for quick and easy draining.
- Ample “cool zone” prevents trapped food particle carbonization while extending oil life.
- Highest BTUs for instant recovery at during extreme peak periods.
- Rugged double layer access door.
- Thermostatic control from 200°F - 400°F.
- Millivolt System with 100% safety shut off.
- No electrical power required.
- 304 Stainless Steel precision TIG welded tank for long life.
- Removable hanger accommodates two fry baskets.
- 1/2 NPT gas inlet in rear of unit.
- One year limited warranty, parts and labor..

OPTIONAL FEATURES

- Stainless Steel tank cover.
- Casters (2 locking).
- Matching “Dump Station”.
- Stainless Steel splash guard (removable & tool-less).
- Heat lamp for model #ARFDS, Stainless Steel work top/side tray.
- Stainless Steel side tray with pan & cut out.
- Stainless Steel Spreader work top solid surface. 12", 18" & 24".
- Quick disconnect and flexible gas hose.



You get a faster and better fryer from American Range, with the latest technology incorporated into its design, and tons of features and benefits to suit the everyday demanding needs especially during extreme operating periods. Bringing added value and assured performance, by offering the highest BTU rating for superior recovery. The ample cool zone prevents food particles from carbonization while extending oil life. Our unique vessel tank design features a deeper oil level, for larger food products, and a sloping vessel bottom for quick and complete draining of oil and debris.

Its special design tube shields provide a uniform heating pattern for positive, more consistent frying results. Equipped with a Millivolt Control System, and a 100% safety shut off valve. No electrical power is required. Conveniently located controls for easy access for operators, maintenance and service. All Stainless Steel heavy duty exterior. Durable, double panel door, rugged base and removable Stainless Steel basket guide. Equipped with two nickel plated baskets with cool grip plastic coated handles provide maximum operator comfort.

SCALE: NOT TO SCALE

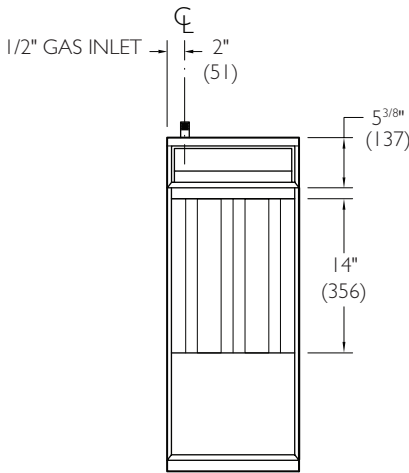

TOP VIEW

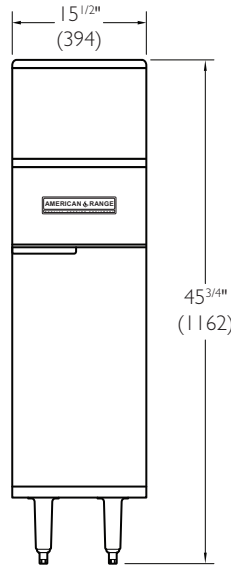

FRONT VIEW

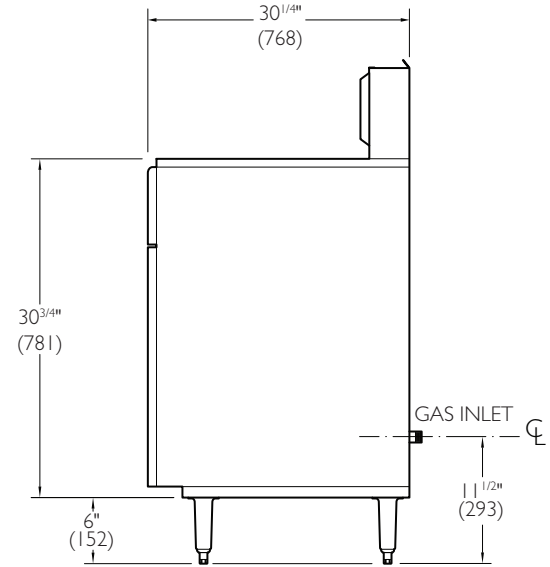

SIDE VIEW

AF SERIES HEAVY DUTY RESTAURANT FRYER

Model	Total BTU	KW	Width	Depth	Height	Cooking area	No. of Burners	Shipping Weight	Lbs.	(Kg.)
AF-35/50 35lbs. - 50lbs. (11-20)	120,000	35	15-1/2" (394mm)	One Pot 30 1/2" (788mm)	45 3/4" (1162)	14" x 14" (356 x 356)	3		163	(74)
AF-50/25 (1) 20lbs. - 30lbs. (11-15) (1) 35lbs. - 50lbs. (19-28)	200,000	47	22 3/4" (565)	Split Pot 30 1/2" (768)	45 3/4" (1162)	(1) 8 3/4" x 14" (171 x 356) (1) 18" x 18" (457 x 457)	5		225	(102)

Must ship from factory with proper gas type. **N**=Natural gas **L**= LP Gas Must provide **N** or **L** after model number for type of gas needed. **Example: AF-35/50-L**

FEATURES

- Fryer vessel tank: All Stainless Steel high quality construction, 16 gal. #304 material.
- Exterior: All Stainless Steel front, sides, door and basket hanger/flue riser.
- Stainless Steel Door: Durable double layer access door
- Basket Hanger: Removable basket hanger accommodates a large fryer basket.
- Fryer Baskets: Nickel plated fryer basket with cool grip plastic coated handle for operator safety and ease.
- millivolt control system: No electrical hook up required.
- Thermostatic Control: Thermostat adjusts from 200°F to 400°F.
- Safety shut off System: 100% gas shut off when temperature reaches the hi-limit.
- Combination Gas Valve: Includes pressure regulator and pilot ignition system, hermetically sealed for operating stability. 1/2" NPT gas inlet in rear.
- Basket support screen provided.
- Drain Valve: 1" (32) diameter opening for easy draining of oil.
- Plastic coated handle for safety.
- Legs: 6" (157) high chrome plated adjustable legs.

OPTIONAL FEATURES

- Casters: 6" (152) high casters front two with locking brakes.
- Tank Cover: Stainless Steel cover to fit over tank vessels.
- Joiner Strip: Connects two fryers and prevents oil from getting in between the fryers or drain station.
- Quick Disconnect: Gas Hose with restraining device for added safety.
- Dump Station: Stainless Steel dump station with door and convenient cabinet below.
- Stainless Steel side tray for working surface or dump station, can be used with optional heat lamp.
- Stainless Steel Splash Guard (removable and tool-less).

ELECTRICAL REQUIREMENTS

Millivolt Pilot System: Requires no electrical connection.

CLEARANCES: For use only on non-combustible floors. legs or casters are required, or 2" (51 mm) overhang is required when curb mounted. Clearance from non-combustible walls is 0". When unit is placed next to combustible walls, clearances must exceed 12" (305 mm) on sides, and 4" (102 mm) from rear.

GAS SUPPLY: 3/4" NPT Gas inlet 7" to 9" W.C., Manifold pressure is 5.0" W.C. for natural gas, or 11" - 12" Manifold pressure is 10.0" W.C. for propane gas. Specify type of gas and altitude if over 2000 feet.

*The American Range Company continually improves its products and reserves the right to change materials, specifications and dimensions without notice.

This unit is manufactured for commercial use only.