

SPECTRUM

winco®

ELECTRIC COUNTERTOP CHAMBER VACUUM PACKAGING MACHINE

Installation and Operating Instruction Manual



11½"
SEAL
BAR

EVPM-12



Model	Voltage	Power	Amperage	Plug Type	Vacuum Pump	Overall Dimensions			Product Weight
						Length	Depth	Height	
EVPM-12	110-120V~ 60Hz	630W	5.25 A	NEMA 5-15P	Dry	14-1/8" (359mm)	16-7/8" (429mm)	14-1/2" (368mm)	53.8 lbs 24.4kgs
						Chamber Dimensions			
						12" (300mm)	13-7/8" (350mm)	5-1/2" (140mm)	
						Seal Bar	Seal Wire		
						11-1/2" (295mm)	0.14" (3.5mm)		

BEFORE OPERATING ANY EQUIPMENT, READ AND FAMILIARIZE YOURSELF WITH THESE USE AND SAFETY INSTRUCTIONS

*Congratulations on your purchase of this SPECTRUM commercial Vacuum Sealer. When used as intended, and with proper care and maintenance, you are sure to experience years of reliable operation from this equipment. To ensure best results, it is important that you read and follow the instructions in this manual carefully. **It is important to keep these instructions in a safe place for future reference.***

Electric Countertop Vacuum Sealer

Important For Future Reference

Please complete this information and retain this manual for the life of the equipment. For Warranty Service and/or parts, this information is required.

Model Number

Serial Number

Date Purchased



WARNING: IMPROPER INSTALLATION, ADJUSTMENT, ALTERATION, SERVICE OR MAINTENANCE CAN CAUSE PROPERTY DAMAGE, INJURY, OR DEATH. READ THE INSTALLATION, OPERATION, AND MAINTENANCE INSTRUCTIONS THOROUGHLY BEFORE INSTALLING OR SERVICING THIS EQUIPMENT.

AVERTISSEMENT: TOUTE INSTALLATION, RÉGLAGE, MODIFICATION, RÉPARATION OU ENTRETIEN INCORRECT PEUT OCCASIONNER DES DOMMAGES MATÉRIELS, DES BLESSURES GRAVES OU LA MORT. LIRE LES INTRUCTIONS D'INSTALLATION, D'UTILISATION ET D'ENTRETIEN ATTENTIVEMENT AVANT D'INSTALLER OU DE RÉPARER CET APPAREIL.



CAUTION: THESE MODELS ARE DESIGNED, BUILT, AND SOLD FOR COMMERCIAL USE ONLY. IF THESE MODELS ARE POSITIONED SO THE GENERAL PUBLIC CAN USE THE EQUIPMENT, MAKE SURE THAT CAUTION SIGNS, WARNINGS, AND OPERATING INSTRUCTIONS ARE CLEARLY POSTED NEAR EACH UNIT SO THAT ANYONE USING THE EQUIPMENT WILL USE IT CORRECTLY AND NOT INJURE THEMSELVES OR HARM THE EQUIPMENT.

ATTENTION: CES MODÈLES SONT CONÇUS, FABRIQUÉS, ET VENDUS POUR UN USAGE COMMERCIAL SEULEMENT. SI CES MODÈLES SONT PLACÉS POUR QUE LE GRAND PUBLIC PUISSE LES UTILISER, ASSUREZ-VOUS QUE LES CONSIGNES D'ATTENTION, D'AVERTISSEMENT, ET LES INSTRUCTIONS D'UTILISATION SOIENT CLAIREMENT AFFICHÉES PRÈS DE CHAQUE UNITÉ DE SORTE QUE N'IMPORTE QUEL UTILISATEUR DE L'APPAREIL L'EMPLOIE CORRECTEMENT ET NE SE BLESSE PAS OU N'ENDOMMAGE PAS L'APPAREIL.



WARNING: A FACTORY AUTHORIZED SERVICE PROVIDER SHOULD HANDLE ALL MAINTENANCE AND REPAIR. BEFORE DOING ANY MAINTENANCE OR REPAIR, FOLLOW SERVICE SET UP ARRANGEMENT ON PAGE 11.

AVERTISSEMENT: UN TECHNICIEN AUTORISÉ PAR L'USINE DEVRA EFFECTUER TOUT L'ENTRETIEN ET LES RÉPARATIONS. AVANT DE FAIRE TOUT ENTRETIEN OU RÉPARATION, VEUILLEZ CONTACTER WINCO.



Introduction

Congratulations on the purchase of your SPECTRUM™ Commercial Vacuum Sealer. Please take time to carefully read through this manual to ensure the machine is operated and maintained properly, to ensure the best possible performance from the product for many years.

SPECTRUM will not accept liability for the following if:

- The instructions in this manual have not been followed correctly.
- Non-authorized personnel have tampered with the machine.
- Non-original spare parts are used.
- The machine has not been handled and cleaned correctly.
- There is any use damage to the unit.

Immediately Inspect for Shipping Damage

All containers should be examined for damage before and during unloading. The freight carrier has assumed responsibility for its safe transit and delivery. If equipment is received damaged, either apparent or concealed, a claim must be made with the delivering carrier.

- A. Apparent damage or loss must be noted on the freight bill at the time of delivery. It must then be signed by the carrier representative (Driver). If this is not done, the carrier may refuse the claim. The carrier can supply the necessary forms.
- B. If concealed damage or loss is not apparent until after equipment is uncrated, a request for inspection must be made to the carrier within 15 days. The carrier should arrange an inspection. Be certain to keep all contents and packaging material.

Electric Countertop Vacuum Sealer

Table of Contents

Specifications	1
Warnings	2
Introduction	2
Packaging	3
Installation	4
Food Safety	5
Operation	6
Cleaning, Care & Maintenance	7
Safety	7
Troubleshooting	8
Service & Repair	8
Exploded View	9
Parts List.....	9
Limited Warranty	10

Package Contents

All units come with an Operating Instruction Manual and the following:

- SPECTRUM™ Commercial Vacuum Sealer

SPECTRUM prides itself on quality and service, ensuring that at the time of packing, all products are supplied fully functional and free of damage. Should you find any damage as a result of freight, please contact your SPECTRUM dealer immediately.

Unpacking the Equipment

DISPOSE OF ALL PACKAGING MATERIALS IN AN ENVIRONMENTALLY RESPONSIBLE MANNER.

1. Remove all packing materials and tape, as well as any protective plastic and cardboard, from the unit.
2. Clean any glue residue left over from the plastic or tape.
3. Place the unit in the desired position and height.

Installation and start-up must be performed by a qualified installer who has thoroughly read, understands and follows these instructions.

Please keep this manual in a safe place for future use!

NOTE

Please remember that this manual and the warning labels do not replace the need to be alert, to properly train and supervise operators, and to use common sense when using this equipment.

Installation

These instructions should be followed at all times. Failure to follow these instructions could result in injury to yourself and others.

TO REDUCE RISK OF INJURY OR DAMAGE TO THE UNIT:

1. Read this manual thoroughly before installation and operation. **DO NOT** proceed with installation and operation if you have any questions or do not understand anything in this manual. Contact your representative or the manufacturer first.

WARNING ⚠️ AVERTISSEMENT		
	<p>Fire Hazard. Correct installation precautions, procedures and regulations must be followed. Operation and safety training is necessary for all users of this equipment.</p>	<p>Risque d'incendie La surchauffe des vapeurs d'huile ou de l'huile peut s'enflammer et provoquer un incendie. Surveillez la température, la qualité et le niveau d'huile. Utilisez et entretenez le système d'élimination des vapeurs d'huile.</p>
	<p>The equipment must be installed by qualified personnel only. Correct installation precautions, procedures and regulations must be followed in order to reduce the risk of fire. Hood and fire suppression systems must be maintained per manufacturer's guidelines. Only qualified and trained personnel are to use this equipment.</p>	<p>Faire chauffer l'huile avec précaution. Si l'huile fume, réduire le feu. Ne pas laisser l'appareil sans surveillance. Si le feu se produit, éteindre l'appareil, couvrir jusqu'à refroidissement. Ne pas mettre l'eau dans l'huile chaude ou enflammée. Ne faites pas fonctionner avec de l'huile sous la barre d'huile. L'huile sale a un point d'éclair plus bas. Remplacer l'huile sur une base régulière. Maintenir le niveau d'huile correct. Utiliser un système d'évacuation de la vapeur d'huile (capot) pour réduire l'accumulation de graisse et d'huile sur les surfaces de paroi ou de plafond.</p>

2. Remove the SPECTRUM™ Commercial Vacuum Sealer from the packaging. Be certain that all protective plastics and residues are thoroughly cleaned from its surface.
3. Place your Vacuum Sealer on a firm level surface. Local standards and regulations should be consulted in order to abide by standards set in relation to positioning, spacing, and ventilation. SPECTRUM recommends that you allow no less than 4" for a ventilation gap around the perimeter of this unit. Common sense should be used when choosing position and operation of this product.



Do not position or operate near combustible materials/flammable objects.

Ne pas placer ni faire fonctionner l'appareil près de matériels combustibles ou d'objets inflammables.

WARNING ⚠️ AVERTISSEMENT		
	<p>Electrical Shock Hazard Keep water and other liquids from entering the inside of the unit. Liquid inside the unit could cause an electrical shock.</p>	<p>Risque de choc électrique Conserver l'eau et d'autres liquides de pénétrer à l'intérieur de l'appareil. Liquide à l'intérieur de l'appareil pourrait provoquer un choc électrique.</p>
	<p>Do not spray water or cleaning products. Liquid could contact the electrical components and cause a short circuit or an electrical shock. Do not use unit if power cord is damaged or has been modified.</p>	<p>Ne pas pulvériser de l'eau ou des produits de nettoyage. Le liquide pourrait contacter avec les composants électriques et causer un court-circuit ou un choc électrique. Ne pas utiliser l'appareil si le cordon d'alimentation est endommagé, ou a été modifié.</p>

4. Proper connections and power supply are essential for efficient performance. Supply the appropriate power and connect to source; your Vacuum Sealer is now ready to turn on and operate. (For power supply please see technical specification on page 1).
Fournir l'alimentation secteur appropriée et brancher l'appareil à la source d'alimentation ; votre Machine Scellant Sous Vide est maintenant prête à être allumée et à fonctionner. (Pour l'alimentation, veuillez voir la fiche technique, page 1).
5. The units are wired to be used with a standard 110V/AC receptacle and may be plugged into any convenient outlet.
6. The installation of the unit must conform to the NATIONAL ELECTRIC CODE, ALL LOCAL ELECTRIC CODES AND ORDINANCES, AND ALL THE LOCAL ELECTRICAL COMPANY RULES AND REGULATIONS. Additionally, we recommend a 4" spacing surrounding the unit in order to provide adequate ventilation.

Proper Grounding · Mise à la terre correcte

This machine is provided with a three-pronged grounding plug. The outlet to which this plug is connected must be properly grounded. If the receptacle is not the proper grounding type, contact an electrician. **DO NOT**, under any circumstances, cut or remove the third ground prong from the power cord or use any adapter plug.

Cette machine est équipée d'une fiche à trois broches. La prise sur laquelle cette fiche est branchée doit être correctement mise à la terre. Si la prise n'est pas le type de mise à la terre, contactez avec un électricien. NE PAS, en aucun cas couper ou enlever la troisième broche de terre à partir du cordon d'alimentation ou utiliser un adaptateur.

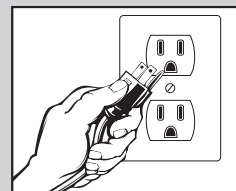

**USE A GROUNDED OUTLET
DO NOT ADD AN ADAPTOR
TO THE PLUG**

**UTILISER UNE PRISE AVEC MISE
À LA TERRE NE PAS AJOUTER UN
ADAPTEUR SUR LA FICHE**

Food Safety

FOOD SAFETY PRECAUTIONS

The Vacuum Sealer will help keep food fresher up to 5 times longer than under normal circumstances. However, there are certain basic guidelines that should always be followed in order to package foods safe to eat. Neglecting these basic guidelines can result in food spoilage, and in some cases, illness or death.

To preserve foods safely, it is important to maintain low temperatures. You can significantly reduce the growth of microorganisms at temperatures of 40°F (4°C) or below. Freezing at 2°F (-17°C) does not kill microorganisms, but stops them from growing. For long-term storage, always freeze perishable foods that have been vacuum packed.

- Only vacuum seal fresh foods. Please keep in mind that not all foods benefit from vacuum packaging. Do not use old or rancid foods. An already bad product does not improve with vacuum sealing.
- Fresh foods (Meats, vegetables, cheeses, etc.) should be refrigerated at 34°F or below or frozen after vacuum sealing.
- Never vacuum package garlic or fungi like mushrooms. A dangerous chemical reaction takes place when air is removed, causing these foods to be dangerous if ingested.
- The foods susceptible to botulinum should be refrigerated for a short term and frozen for long-term storage. Consume immediately after heating.
- Vegetables need to be blanched before vacuum packaging. This process stops the enzyme action, which leads to loss of flavor, color and texture.
- Cruciferous vegetables (broccoli, sprouts, cabbage, cauliflower, kale, turnips) naturally emit gases during storage. Therefore, after blanching, they must be stored in the freezer only.
- Vacuum packaging is not a substitute for canning, refrigeration, or freezing. Any perishable food that requires refrigeration must still be refrigerated or frozen after vacuum packaging.

Vacuum sealing removes a high percentage of air. This slows the growth of most living microorganisms, which degrade food, such as aerobic bacteria and molds. However, some forms of bacteria such as clostridium botulinum (responsible for botulism) are anaerobic and grow in the absence of oxygen.

FOOD	VACUUM FREEZER STORAGE	VACUUM FRIDGE STORAGE	TYPICAL STORAGE
Fresh Beef & Veal	1-3 years	1 month	1-2 weeks
Ground Meat	1 year	1 month	1-2 weeks
Fresh Pork	2-3 years	2-4 weeks	1 week
Fresh Fish	2 years	2 weeks	3-4 days
Fresh Poultry	2-3 years	2-4 weeks	1 week
Smoked Meats	3 years	6-12 weeks	2-4 weeks
Fresh Produce, Blanched	2-3 years	2-4 weeks	1-2 weeks
Fresh Fruits	2-3 years	2 weeks	3-4 days
Hard Cheeses	6 months	6-12 weeks	2-4 days
Sliced Deli Meats	not recommended	6-12 weeks	1-2 weeks
Fresh Pasta	6 months	2-3 weeks	1 week

Operation

Understanding the control panel

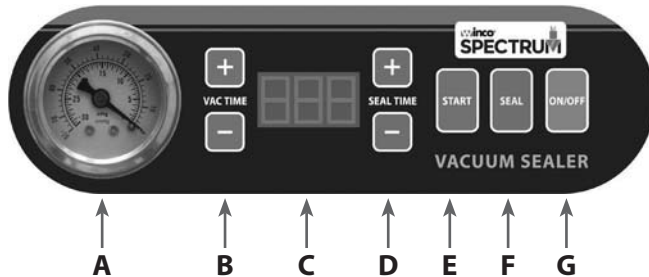

- A. Vacuum Gauge**
Shows the vacuum level inside the vacuum chamber
- B. Vacuum Time Adjustment Buttons**
- C. LED Display**
Shows the vacuum or seal time.
- D. Seal Time Adjustment Buttons**
- E. "Start" Button**
If machine does not start automatically after closing the lid, press "Start" button.
- F. "Seal" Button**
Press "Seal" button to stop vacuum cycle and instantly seal the bag to prevent crushing delicate items.
- G. "On/Off" Button**
After using the machine, press the "Off" button before unplugging the machine.
During the working processes, press the "On/Off" button to stop any process.

Preparing food for the vacuum sealer

1. Vegetables must be blanched before being packaged. Place in boiling water or microwave until heated through but still crunchy.
2. Select the proper size vacuum pouch for your food. Allow a minimum of 1" to 2" of extra space at the top of the pouch to ensure a quality air-tight seal.
3. Place the food into the pouch.

Operating the vacuum sealer

1. Plug the machine into grounded electrical outlet. The LED Display (C) on the control panel will read "OFF".
2. Open the vacuum lid and press "ON/OFF" button (G).
When the vacuum lid is **open**, LED display (C) will show "ON".
When the vacuum lid is **closed**, LED (C) display will show "CLO".
3. With the LED Display (C) showing "ON." Adjust the Vacuum Time (B) and Seal Time (D) by pressing the "+" or "-" buttons to desired times. **For the initial test, set the vacuum time to 30 seconds.** Adjust vacuum time accordingly to achieve the vacuum required. Depending on the pouch size and the amount of product in the package, the vacuum time can vary from 5-60 seconds.
For the initial test, set the seal time to 5 seconds. Adjust the time accordingly to achieve a perfect seal, the seal time can vary from 3-9 seconds.
4. Place the vacuum bag with food into the vacuum chamber.
Keep pouches that contain liquids or wet product below the height of the seal bar.
Lay the pouch flat in the chamber with the opening of the pouch across the seal bar.
Slide open ends of the pouch into the bag clamp to hold in place.
NOTE: The entire pouch, including the opening must remain inside the chamber.

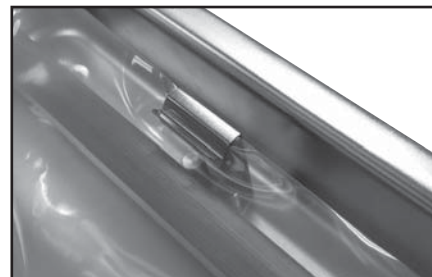

5. Close the vacuum lid. The machine will start automatically. The number on LED display will count down from preset value.
6. When the vacuum is finished, the machine will seal automatically. The number on LED display will count down from preset value.
7. Inspect the pouch.
Check the quality of the vacuum by looking at the tightness of the pouch and the product. If you notice air pockets increase the vacuum time by 5 seconds, and try again.
The vacuum time could take up to 60 seconds depending on the pouch size and the volume of the product being packaged.
Check the quality of the pouch seal. A positive seal will look "clear" upon inspection. If the seal is "spotty or incomplete" increase the sealing time by 1. If the seal is "white or milky" decrease the seal time by 1.

WARNING ⚠️ AVERTISSEMENT	
 <p>Electrical Shock Hazard Keep water and other liquids from entering the inside of the unit. Liquid inside the unit could cause an electrical shock.</p>	<p>Risque de choc électrique Conserver l'eau et d'autres liquides de pénétrer à l'intérieur de l'appareil. Liquide à l'intérieur de l'appareil pourrait provoquer un choc électrique.</p>
<p>Do not spray water or cleaning products. Liquid could contact the electrical components and cause a short circuit or an electrical shock. Do not use unit if power cord is damaged or has been modified.</p>	<p>Ne pas pulvériser de l'eau ou des produits de nettoyage. Le liquide pourrait contacter avec les composants électriques et causer un court-circuit ou un choc électrique. Ne pas utiliser l'appareil si le cordon d'alimentation est endommagé, ou a été modifié.</p>

 HOT	WARNING ⚠️ AVERTISSEMENT	
	Burn Hazard. When in operation, the surface of the Vacuum Sealer will be hot. <i>Please take extreme caution.</i>	Risque de brûlure. Ne touchez pas les surfaces chaudes ou chauffées liquide tout appareil chauffe ou en fonctionnement.
USE CAUTION WHEN TOUCHING THE UNIT.	Ne touchez pas le liquide chaud ou les surfaces de chauffage lorsque l'appareil chauffe ou en fonctionnement.	

	WARNING ⚠️ AVERTISSEMENT	
	Electrical Shock Hazard Keep water and other liquids from entering the inside of the unit. Liquid inside the unit could cause an electrical shock.	Risque de choc électrique Conserver l'eau et d'autres liquides de pénétrer à l'intérieur de l'appareil. Liquide à l'intérieur de l'appareil pourrait provoquer un choc électrique.
Do not spray water or cleaning products. Liquid could contact the electrical components and cause a short circuit or an electrical shock. Do not use unit if power cord is damaged or has been modified.	Ne pas pulvériser de l'eau ou des produits de nettoyage. Le liquide pourrait contacter avec les composants électriques et causer un court-circuit ou un choc électrique. Ne pas utiliser l'appareil si le cordon d'alimentation est endommagé ou a été modifié.	

Cleaning, Care & Maintenance

To maintain the appearance and increase the service life, clean your unit daily. The SPECTRUM™ Vacuum Sealer should be cleaned after each day's operation; however, the unit may require more frequent cleaning, depending on the volume of production.

1. Switch power off, disconnect from the outlet, and let the Vacuum Sealer cool down before cleaning.
2. The Vacuum Sealer can be cleaned with a damp cloth using hot, soapy water.
3. Do not immerse completely in water or use hose to clean.
4. Warm soapy water is recommended for cleaning; prolonged use of cleaning agents may cause damage to stainless steel.

Safety

SAFETY PRECAUTIONS

Before installing and operating this equipment be sure everyone involved in its operation are fully trained and aware of all precautions. Accidents and problems can result from a failure to follow fundamental rules and precautions.

- A WINCO® Approved Recommended Qualified Service Technician should carry out repairs if necessary. Do not remove any components or service panels on this product.
- Before cleaning, switch off power and disconnect power cord from the outlet.
- **Do not immerse unit in water or use hose to clean.**
Ne jamais immerger l'appareil dans l'eau ni utilisez un jet d'eau pour le nettoyer.
- If the power cord is damaged, it must be replaced by a WINCO® Approved Recommended Qualified Service Technician in order to avoid a hazard.

Troubleshooting

If your SPECTRUM™ Vacuum Sealer does not operate, please check the following before placing a service call:

ISSUE	MIGHT BE CAUSED BY	RECOMMENDED SOLUTION
The unit is not working and the display is not on	Lack of power	Check main power supply
	Power switch has not been turned on	Check that unit is correctly plugged in and turned on
	Wrong operating procedure	Refer to operating instructions
	Plug and lead are damaged	Replace damaged power cable - <i>Replacement must be done by an authorized service provider</i>
	Internal wiring fault	Replace faulty wiring - <i>Replacement must be done by an authorized service provider</i>
The unit is working but the display is not on	Faulty control board	Replace faulty control board - <i>Replacement must be done by an authorized service provider</i>
Display is on but the unit is not sealing	Faulty sealing bar	Replace faulty sealing wire or sealing bar
	Seal time may not be long enough	Increase seal time and try again
Vacuum pouch loses vacuum after being sealed	Sharp items puncturing small holes in pouch.	Cover sharp edges with paper towel and vacuum in a new pouch.
	Some fruits and vegetables can release gases if not properly blanched or frozen before packaging.	Open pouch. If you think food spoilage has begun, discard food. If food spoilage has not yet begun, consume immediately. If in doubt, discard food.
	Sealing bar	Check sealing bar and try again
Pouch is not sealing properly	Seal time may not be long enough	Increase seal time and try again
	Moisture, food particles or debris are present in the seal area	Wipe the inside of the pouch clean and try again.
	Pouch is not properly placed along the seal bar.	Make sure the entire pouch is over the seal bar and there are no wrinkles in pouch material.
E01 appears on the display screen	Micro switch is not closed when the machine enters the heat seal mode.	Check lid is closed and try again
		Check micro switch connection

Service and Repair

THIS EQUIPMENT MUST ONLY BE SERVICED BY AN AUTHORIZED AGENT.

NOTE

Parts protected by the manufacturer or its agent are not to be adjusted by the installer unless the installer is an authorized service agent.

If you have any questions or problems DO NOT send unit to WINCO® without first contacting our customer service department.

See "Limited Warranty" section on page 10 for details.

Exploded View

MODEL: EVPM-12

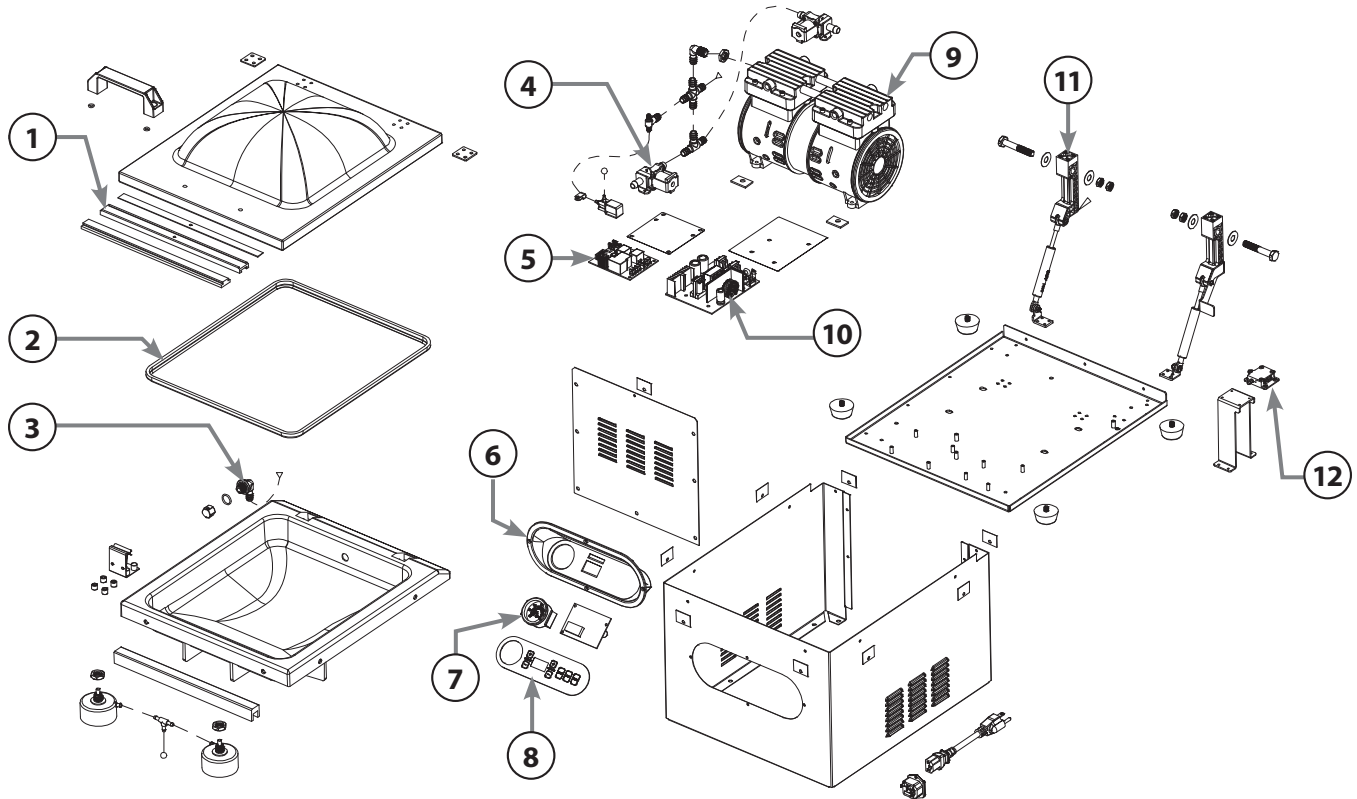

Parts List

MODEL: EVPM-12

#	Description	Part #	QTY
1	Seal bar assembly	EVPM-P1	1
2	Sealing ring	EVPM-P2	1
3	Water inlet valve	EVPM-P5	1
4	Small solenoid valve	EVPM-P11	2
5	Main board	EVPM-P10	1
6	Control board	EVPM-P9	1

#	Description	Part #	QTY
7	Vacuum gauge	EVPM-P7	1
8	Membrane switch	EVPM-P8	1
9	Vacuum pump	EVPM-P6	1
10	Power board	EVPM-P4	1
11	Up-down piston assembly	EVPM-P3	2
12	Microswitch assembly	EVPM-P12	1

Please contact factory for special order parts not listed.

Limited Warranty

WINCO® warrants to the original purchaser of new equipment that said equipment, when installed in accordance with our instructions within North America and subjected to normal use, is free from defects in material or workmanship for a period of 1 year. The labor warranty is one year from original installation or 18 months from actual factory shipment date, whichever date occurs first.

THIS WARRANTY IS IN LIEU OF ALL OTHER WARRANTIES, WHETHER EXPRESSED OR IMPLIED. WINCO EXPRESSLY DISCLAIMS ANY IMPLIED WARRANTY OF MERCHANTABILITY OR EXPRESSED OR IMPLIED WARRANTY OF FITNESS FOR A PARTICULAR PURPOSE.

WINCO'S OBLIGATION AND LIABILITY UNDER THIS WARRANTY IS EXPRESSLY LIMITED TO REPAIRING AND REPLACING EQUIPMENT THAT PROVES TO BE DEFECTIVE IN MATERIAL OR WORKMANSHIP WITHIN THE APPLICABLE WARRANTY PERIOD.

IN NO EVENT SHALL WINCO BE LIABLE FOR INCIDENTAL OR CONSEQUENTIAL DAMAGES TO BUYER OR ANY THIRD PARTY, INCLUDING, WITHOUT LIMITATION, LOSS OF PROPERTY, PERSONAL INJURY, LOSS OF BUSINESS OR PROFITS OR OTHER ECONOMIC LOSSES, OR STATUTORY OR EXEMPLARY DAMAGES, WHETHER IN NEGLIGENCE, WARRANTY, STRICT LIABILITY, OR OTHERWISE.

This warranty is given only to the first purchaser from a retail dealer. No warranty is given to subsequent transferees.

Warranty does not cover product failures caused by: failure to maintain, neglect, abuse, damage due to excess water, fire, normal wear, improper set up and use. Periodic maintenance is not covered.

This warranty is not in force until such time as a properly completed and digitally signed Installation/Warranty Registration has been received by WINCO within 30 days from the date of installation.

Limited Warranty (continued)

WARRANTY SERVICE

To initiate warranty service contact: **EquipService@wincous.com** or call: 973-295-3899

DO NOT send unit to WINCO® without first contacting our customer service department.

Please provide or have the following information available:

- Model & Serial Number (located on the silver identification tag, on side or rear of unit)
- Date of Purchase
- Purchase Dealer
- Operator / Installation Contact Information
- Business Name & Business Address
- Contact Name & Contact Telephone Number

REGISTER ONLINE AT:

<http://www.wincous.com>

Proof of purchase is required to extend warranty more than 1 year from date of shipment from the factory.

THE FOREGOING WARRANTY PROVISIONS ARE A COMPLETE AND EXCLUSIVE STATEMENT BETWEEN THE BUYER AND SELLER. WINCO® NEITHER ASSUMES NOR AUTHORIZES ANY PERSONS TO ASSUME FOR IT ANY OTHER OBLIGATION OR LIABILITY IN CONNECTION WITH SAID EQUIPMENT.

Examples of items not covered under warranty, but not limited to just these items:

1. Natural disasters (ie: earthquakes, tornadoes, hurricanes, etc.), fire, water damage, burglary, accident, theft.
2. Freight damage.
3. Improper installation or alteration of equipment.
4. Use of generic or after-market parts.
5. Repairs made by anyone other than a WINCO® designated service provider.
6. Lubrication.
7. Expendable wear parts, adjustable feet, blown fuses, lamps, etc.
8. Normal product maintenance.
9. Misuse or abuse.
10. Normal wear and tear items such as light bulbs, fuses, and exterior finishes.

Warranty voided if:

1. Product is altered by user
2. Serial number plate is removed
3. Product is installed in a prison or any correctional facility.

Please keep this manual in a safe place for future use!



SPECTRUM 

Model: EVPM-12

www.wincous.com