



"WE MAKE THE KITCHEN BETTER!"

ATOSA USA, INC.

Toll Free: 855-855-0399 Email: info@atosausa.com

www.atosa.com | www.atosausa.com

California, Colorado, Florida, Georgia, Illinois,
New Jersey, Ohio, Texas, Washington

Mega Top Sandwich Prep Tables

Standard Features

- Stainless steel exterior & interior
- Rear mount compressor with environmentally friendly R290 refrigerant
- Concentrated airflow design for even distribution of airflow around pans. Unmatched cabinet airflow design
- Electronic Temperature Controller
- Removable stainless steel pan liner
- Maintains temperatures between 33°F - 40°F
- Locking divider bars
- Pre-installed 6" deep poly pans
- 9-1/4" cutting board
- Recessed door handle(s)
- Self-closing door(s) with stay open feature
- Magnetic door gasket(s) standard for positive door seal
- One(1) pre-installed shelf per section
- Pre-installed casters

Optional Accessories

- Double overshelf for 27", 36", 48", 60" and 72" models
- Part # 82021902 - 12" cross bar
- Night covers



For the best results of food preservation we recommend setting your refrigerator between 33°F to 38 °F

1. Don't forget to leave the unit some room to breathe!
2. Please clean the condenser frequently to give the unit more fresh air.



2 YEAR PARTS AND LABOR WARRANTY
5 YEAR COMPRESSOR PART WARRANTY

MODELS:

MSF8305GR / MSF3615GR
MSF8306GR / MSF8307GR / MSF8308GR



MSF8305GR



MSF3615GR



MSF8306GR



MSF8307GR



MSF8308GR





“WE MAKE THE KITCHEN BETTER!”

ATOSA USA, INC.

Toll Free: 855-855-0399 Email: info@atosausa.com

www.atosa.com | www.atosausa.com

California, Colorado, Florida, Georgia, Illinois,

New Jersey, Ohio, Texas, Washington

SPECIFICATIONS

Models	Door	Capacity (Cu.Ft.)	Shelves	Casters (inch)	Amps (A)	Voltage (V/Hz/Ph)	HP	Refrigerant	Exterior Dimensions (inch)	Net Weight (lbs)	Gross Weight (lbs)
MSF8305GR	1	7.2	1	2	2.3	115/60/1	1/7	R290	27 ^{1/2} ×36 ^{3/4} ×46 ^{5/8}	170	212
MSF3615GR	2	8.7	2	2	2.3	115/60/1	1/7	R290	36 ^{5/16} ×36 ^{3/4} ×46 ^{5/8}	174	240
MSF8306GR	2	13.4	2	2	2.3	115/60/1	1/7	R290	48 ^{1/5} ×36 ^{3/4} ×46 ^{5/8}	243	293
MSF8307GR	2	17.2	2	2	2.8	115/60/1	1/5	R290	60 ^{1/5} ×36 ^{3/4} ×46 ^{5/8}	284	340
MSF8308GR	3	21.1	3	2	2.8	115/60/1	1/5	R290	72 ^{7/10} ×36 ^{3/4} ×46 ^{5/8}	331	401

PLAN VIEW

MSF8305GR

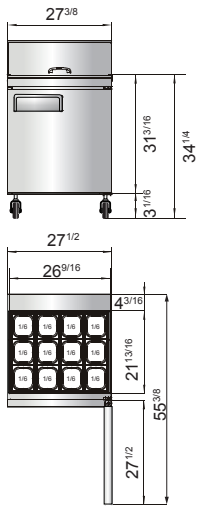

MSF3615GR

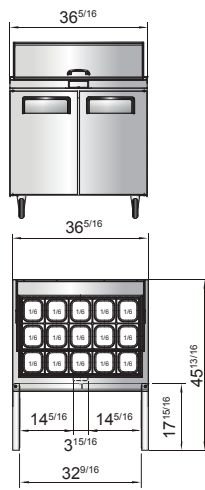

MSF8306GR

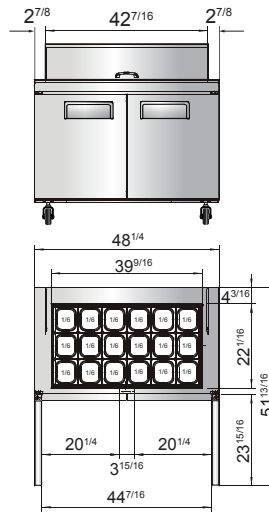

SIDE VIEW

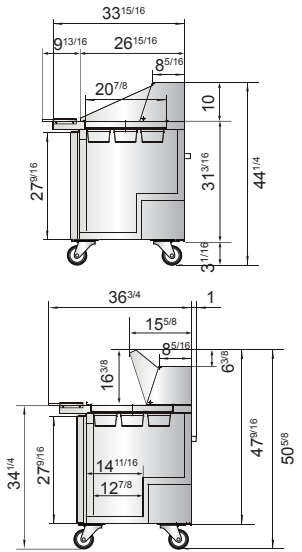

MSF8307GR

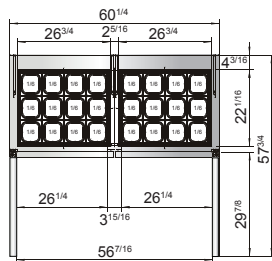
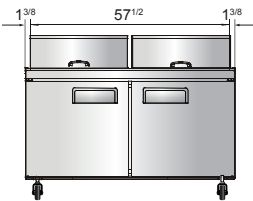

MSF8308GR

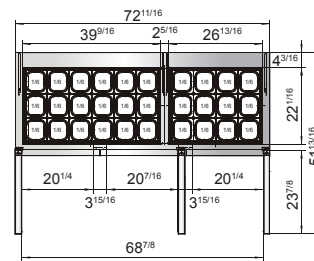
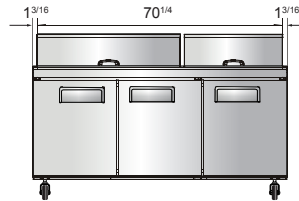

Stainless steel pan liner

Concentrated airflow design for even distribution of airflow around pans

Unmatched cabinet airflow design

Locking divider bars

